

# View Licence Agreement

This Supplemental Agreement No. 1 (“**Supplemental Agreement**”) is dated 20-Dec-19 and made between:

- (1) **HEALTH PROMOTION BOARD**, corporation constituted under the Health Promotion Board Act (Cap. 122B) and having its main office at 3 Second Hospital Avenue, Singapore 168937 (hereinafter referred to as the “**Licensor**”); and
- (2) **F&N Foods Pte Ltd** (UEN No. **196700390K**), a company incorporated and having its registered address at **438 Alexandra Road Alexandra Point Singapore N/A** (hereinafter referred to as the “**Licensee**”).  
(each a “**Party**” and collectively, the “**Parties**”)

## BACKGROUND

- (A) The Parties entered into a licence agreement dated 22-May-19.
- (B) Pursuant to Clause 11(B) of the Licence Agreement, the Parties have agreed to amend the Licence Agreement on and subject to the terms and conditions of this Supplemental Agreement.
- (C) This Supplemental Agreement amends the Licence Agreement

## IT IS AGREED AS FOLLOWS:-

### 1. CONSTRUCTION AND INTERPRETATION

- 1.1. As from the Effective Date, the Licence Agreement shall be read together with this Supplemental Agreement as one document and this Supplemental Agreement shall be considered as part of the Licence Agreement. Save as amended by the Supplemental Agreement, the terms of the Licence Agreement are hereby confirmed and shall remain in full force and effect in accordance to its terms.
- 1.2. In the event of any conflict or inconsistency between any of the terms of this Supplemental Agreement with any of the terms of the Licence Agreement, the terms of this Supplemental Agreement shall prevail.

### 2. EFFECTIVE DATE

- 2.1. This Supplemental Agreement shall take effect on 20-Dec-19 (“**Effective Date**”).

### 3. AMENDMENTS TO THE LICENCE AGREEMENT

- 3.1. The terms of the Licence Agreement together with its schedules shall be replaced in its entirety with the terms in the amended licence agreement annexed hereto under **ANNEX 1**.

### 4. GENERAL

- 4.1. This Supplemental Agreement may be executed in any number of counterparts, each of which when executed and delivered is an original and all of which together evidence the same Supplemental Agreement.
- 4.2. This Supplemental Agreement shall be governed by and construed in accordance with the laws of Singapore.
- 4.3. All disputes between the Parties as to any matter arising out of or in connection with this Supplemental Agreement will be dealt with by the Parties in accordance with the terms of Clause of the Licence Agreement (as amended by the terms of this Supplemental Agreement).

**IN WITNESS** whereof this Supplemental Agreement has been entered into the day and year first above written.

ACCEPTED FOR AND ON BEHALF OF  
**HEALTH PROMOTION BOARD**

Name: **Ann Low**  
Designation: **Senior Deputy Director**

ACCEPTED FOR AND ON BEHALF OF  
**F&N Foods Pte Ltd**

Name: **Norman Phua**  
Designation: **Brand Manager**

## ANNEX 1

Amended licence agreement

**THIS AGREEMENT** is made on 20-Dec-19 between:-

- (3) **HEALTH PROMOTION BOARD**, corporation constituted under the Health Promotion Board Act (Cap. 122B) and having its main office at 3 Second Hospital Avenue, Singapore 168937 (hereinafter referred to as the “**Licensor**”); and
- (4) **F&N Foods Pte Ltd** (UEN No. 196700390K), a company incorporated and having its registered address at **438 Alexandra Road Alexandra Point Singapore N/A** (hereinafter referred to as the “**Licensee**”).  
(each a “**Party**” and collectively, the “**Parties**”)

**WHEREAS:-**

- (A) The Licensee is engaged in the business of manufacturing/distributing the Product(s) (defined below).
- (B) The Licensor was established with a mission to (i) empower Singaporeans to achieve optimal health throughout life; (ii) ensure accessibility to health information and preventive health services; (iii) collaborate with public, private and community organisations in health promotion; (iv) create a conducive environment for leading a healthy lifestyle; and (v) be a centre of excellence for health promotion. The Licensor is also the owner of all widely recognised rights, title and interest in and to the Trademark.
- (C) The Licensee desires to obtain a non-exclusive and non-transferable right to use the Trademark on the Product(s), and avail itself of the benefits associated with having the Product(s) acknowledged by the Licensor as being part of the Licensor’s Healthier Choice Symbol Programme (more details of the Licensor’s Healthier Choice Symbol Programme is located on the Licensor’s website at <http://www.hpb.gov.sg>).
- (D) The Licensor is willing to grant the Licensee such non-exclusive and non-transferable right to use the Trademark on the Product(s) on the terms and conditions hereinafter provided.

**NOW, THEREFORE**, the Parties agree as follows:-

## 1 DEFINITION

- a. In this Agreement, unless the subject or context otherwise requires, the following words and expressions shall have the following means
  - “**Accredited Laboratory**” shall refer to a laboratory that is accredited by the Singapore Accreditation Council.
  - “**Analysis**” means the analysis of the Product(s) undertaken by an Accredited Laboratory using (i) the Official Methods of Analysis as prescribed by the Association of Official Analytical Chemists International (“**AOAC**”); and/or (ii) alternative methods of analysis which are generally accepted to be equivalent to that of the AOAC and approved by the Licensor in writing. For the avoidance of doubt, such Analysis shall include an analysis of the nutrients used to substantiate the nutrition information set out in the Panel.
  - “**Application Form**” shall refer to the application form that the Licensee must complete and submit to the Licensor as part of its application to obtain the licence to enable it to use the Trademark pursuant to the terms of this Agreement. The Application Form includes details of the Licensee, including but not limited to the Licensee’s name and contact details.
  - “**Date**” shall have the meaning ascribed to it in Clause 3a.
  - “**Designated Laboratory**” shall have the meaning ascribed to it in Clause 5f.
  - “**First Instance Report**” shall refer to the report of the Analysis issued by the Accredited Laboratory and provided by the Licensee to the Licensor under Clause 2b.
  - “**Handbook on Nutrition Labelling**” refers to the latest version of the Licensor’s Handbook on Nutrition Labelling (located on the Licensor’s website at <http://www.hpb.gov.sg>) which sets out the requirements on nutrition labelling and this Handbook on Nutrition Labelling are incorporated by reference in this Agreement.
  - “**Healthier Choice Symbol Nutrient Guidelines**” refers to the latest version of the Licensor’s guidelines (located on the Licensor’s website at <http://www.hpb.gov.sg>) which sets out the Selected Nutrients and nutritional requirements for each category of products, and these guidelines are incorporated by reference in this Agreement.
  - “**Licensor’s Usage Specifications**” means the specifications issued by the Licensor from time to time governing the use of the Trademark by the Licensee and as set out in **SCHEDULE 3**.
  - “**Packaging**” refers to the packaging of the Product(s).
  - “**Product(s)**” means the product(s) marketed by the Licensee, which have been subject to the Analysis for purposes of this Agreement, which conforms to the standards of the Licensor’s Healthier Choice Symbol Programme, and described in **SCHEDULE 2**
  - “**Product Review**” shall have the meaning ascribed to it in Clause 5a(i);
  - “**Promotional Materials**” shall have the meaning ascribed to it in Clause 4h;
  - “**Rectification Period**” shall have the meaning ascribed to it in Clause 9b(iii).
  - “**Remedial Period**” shall have the meaning ascribed to it in Clause 5g.
  - “**Selected Nutrients**” means the nutrients that are assessed under the Licensor’s Healthier Choice Symbol Nutrient Guidelines.
  - “**Trademark**” refers to the trademark set forth in **SCHEDULE 1**.

- b. Any reference to a statutory provision shall include such provision and any regulations made in pursuance thereof as from time to time modified or re-enacted whether before or after the date of this Agreement so far as such modification or re-enactment applies or is capable of applying to any transactions entered into hereunder and (so far as liability thereunder may exist or can arise) shall include also any past statutory provisions or regulations (as from time to time modified or re-enacted) which such provisions or regulations have directly or indirectly replaced.
- c. Unless otherwise stipulated herein, references to Clauses, Sub-Clauses, Recitals and Schedules are to the clauses, sub-clauses, recitals and schedules of this Agreement.
- d. The headings to the Clauses are for convenience only and shall not be taken into consideration in the interpretation or construction of this Agreement.
- e. Unless the context otherwise requires, words importing the singular number include the plural number and vice versa.
- f. References to any agreement or document including this Agreement shall include such agreement or document as amended, modified, varied, novated, supplemented or replaced from time to time. Any reference to a document being in the agreed terms means in the terms agreed between the Parties and for the purpose of identification signed by the Parties to this Agreement. The Recitals and Schedules of this Agreement shall be read and construed as essential parts of this Agreement.
- g. Any reference in this Agreement to “**Parties**” means all of the parties hereto and “**Party**” means any one of them.

## 2 GRANT OF LICENCE

- a. In consideration of the Licensee’s covenants hereinafter reserved and contained, and subject to the fulfilment of the conditions precedent in Clause 2b below, the Licensor hereby grants to the Licensee a non-exclusive and non-transferable licence to use the Trademark in accordance with the terms of this Agreement. For the avoidance of doubt, the Licensee shall not sub-license the Trademark to any third party without the written consent of the Licensor which may be subject to such additional terms and conditions. The Licensee acknowledges that the Licensor is permitted to licence other parties to use the Trademark at its sole and absolute discretion.
- b. To qualify for a licence under the terms of this Agreement, the Licensee shall provide the Licensor with a report of the Analysis issued by an Accredited Laboratory to show that:
  - (i) the Product(s) comply with the Healthier Choice Symbol Nutrient Guidelines; and
  - (ii) the Product(s) conform to the standards of the Licensor’s Healthier Choice Symbol Programme, and the manner of such conformance is to be determined solely by the Licensor.

## 3 TERM

- a. This Agreement shall come into force on the date first above written (the “**Date**”) and shall remain valid unless terminated in accordance with Clause 9.

## 4 CONDITIONS OF USE OF TRADEMARK

The Licensee hereby undertakes that:

- a. the Product(s) shall, at all times, conform to the contents of the First Instance Report, the Healthier Choice Symbol Nutrient Guidelines and all legal regulations and requirements including but not limited to the Sale of Food Act (Cap. 283) that may be applicable to the Product(s);
- b. it will use the Trademark in accordance with the terms of the Licensor’s Usage Specifications;
- c. it will use the Trademark only in relation to such Product(s) which conform to such quality standards as the Licensor may from time to time require, such standard of quality to be consistent with the standards of the Licensor’s Healthier Choice Symbol Programme;
- d. it will ensure that the Trademark is placed on the Product(s) within three (3) months from the date on which the Licensor notifies the Licensee of the approval of the Licensee’s application to obtain the licence to enable it to use the Trademark pursuant to the terms of this Agreement or such longer period as the Licensor may, in its sole and unfettered discretion, decide;
- e. where the Licensee is a manufacturer of the Product(s), it shall not use the Trademark except in relation to the Product(s) manufactured by it;
- f. where the Licensee engages an original equipment manufacturer to manufacture the Product(s), the Licensee shall not use the Trademark except in relation to these aforementioned manufactured Product(s);
- g. where the Licensee is a distributor of the Product(s), shall have obtained the requisite authority from the manufacturer or supplier of the Product(s) to use the Trademark in connection with the marketing of the Product(s);
- h. it will use the Trademark (including, but without limitation, the presentation of the Trademark on the Product(s), packing, wrappers, notepaper, price lists, advertisements and other promotional materials and the like, whether in physical or electronic form (“**Promotional Materials**”), as respects shaping, printing style, colour, quality of materials used and otherwise only in the form set out in **SCHEDULE 1**, **SCHEDULE 2** and **SCHEDULE 3**, or in other forms that may be approved by the Licensor from time to time;
- i. it will not use the Trademark together or in combination with any other marks, names, words, logos, symbols or devices other than those specified in **SCHEDULE 3** or unless otherwise agreed by the Licensor in writing;

- j. it will not use the Trademark in relation to any goods other than the Product(s) nor use or seek to register any other trade or service marks which are similar to or substantially similar to or so nearly resemble the Trademark as to be likely to cause deception or confusion;
- k. it shall ensure that a Panel is placed on the Packaging and the information contained within the Panel must (i) comply with the requirements as set out in the Handbook on Nutrition Labelling; and/or (ii) be agreed upon or approved by the Licensor in writing;
- l. it shall, when requested to do so by the Licensor, supply the Licensor with any information or document as to the Licensee's use of the Trademark which the Licensor may require, and render any assistance which the Licensor may require to maintain the registration of the Trademark;
- m. it shall, when requested to do so by the Licensor, supply the Licensor with details of all complaints made by customers relating to the Product(s) together with reports on the manner in which such complaints are being or have been dealt with and shall comply with any directions or recommendations given by the Licensor in respect thereof;
- n. it shall consult with the Licensor as to the (i) artwork, form and/or design of the Packaging, which must conform with the requirements in the Handbook on Nutrition Labelling; and (ii) form and content of all Promotional Materials in which the Trademark appears, and the Licensee undertakes not to use the Packaging and/or use or distribute such Promotional Materials unless and until the Licensor shall have approved the same in writing;
- o. it shall not change its corporate name to a name including the Trademark or establish any internet website with a domain name including the Trademark without the prior written consent of the Licensor;
- p. it will include in all Promotional Materials, a statement that the Trademark is the registered trade mark of the Licensor; and
- q. it will use its best endeavours to protect and promote the reputation of the Licensor and its mission and will not engage in any conduct or use the Trademark in a manner which is likely to cause harm to the goodwill attached to the Licensor and/or the Trademark.

## 5 INSPECTION AND AUDIT PROCESS

### Licensee's obligations

- a. Upon the Licensor's request, before the 1st of September of each successive one-year period commencing from the Date, the Licensee shall:
  - (i) take all necessary steps to review the Product(s) to ensure that (i) there is no change in the contents of the Products; and/or (ii) the Product(s) comply with the Healthier Choice Symbol Nutrient Guidelines existing at the point in time (hereinafter referred to as "**Product Review**") by arranging, at its own cost and expense, for samples of the Product(s) to undergo Analysis at an Accredited Laboratory; and
  - (ii) inform the Licensor of the results of the Product Review in writing
- b. The Licensor shall be entitled to terminate this Agreement in its entirety or in respect of any Product(s), by notice in writing, with immediate effect if:
  - (i) the Licensee fails to comply with its obligations under Clause 5a; or
  - (ii) the results of the Product Review shows that (i) there is a change in the contents of the Product(s); and/or (ii) the Product(s) do not comply with the Healthier Choice Symbol Nutrient Guidelines existing at the point in time.
- c. At any time, if there are any changes in the formulation and/or nutritional contents of the Product(s), and such changes do not comply with the Healthier Choice Symbol Nutrient Guidelines existing at the point in time, the Licensor shall be entitled to terminate this Agreement in its entirety or in respect of any Product(s), by notice in writing, with immediate effect.

### Inspection or Testing by Licensor

- d. The Licensor is entitled to conduct independent inspections to ensure that the Product(s) comply with (i) the contents of the Panel, (ii) the Licensee's obligations under this Agreement; and/or (iii) the Healthier Choice Symbol Nutrients Guidelines. If the Products do not comply with (i) the contents of the Panel, (ii) the Licensee's obligations under this Agreement; and/or (iii) the Healthier Choice Symbol Nutrients Guidelines, the Licensor is entitled to require the Licensee to take the necessary remedial steps to ensure that the Products comply with the contents of the Panel and/or the Healthier Choice Symbol Nutrients Guidelines or terminate this Agreement, by notice in writing, with immediate effect. For the avoidance of doubt, any failure on the part of the Licensee to take any remedial steps requested by the Licensor will lead to the termination of this Agreement with, by notice in writing, immediate effect.
- e. The Licensee shall, on prior notice from the Licensor, permit the Licensor and its representatives or agents at all reasonable times access to the premises of the Licensee to inspect the Product(s) as manufactured, distributed and/or offered for sale by the Licensee and the method by which the Product(s) are manufactured, packed and labelled. The Licensee undertakes that it will do such things as may be necessary in order to satisfy the Licensor that such Product(s) are processed, packed and labelled by the methods and in conformity with such specifications and standards of quality as may be from time to time approved by the Licensor pursuant to this Agreement.

- f. On request by the Licensor, the Licensee shall supply to the Licensor, at its own cost and expense, sufficient samples of the Product(s) distributed or offered for sale for the Licensor's inspection. If the Licensor suspects that the Product(s) do not comply with the contents of the Panel, First Instance Report and/or Healthier Choice Symbol Nutrient Guidelines, the Licensor shall send the samples of the Product(s) to a laboratory designated by the Licensor ("**Designated Laboratory**") for Analysis at the Licensee's cost
- g. If the report of the Analysis issued by the Designated Laboratory shows that the Product(s) do not comply with the Healthier Choice Symbol Nutrient Guidelines, the Licensor shall provide the Licensee with a notice of non-compliance, and the Licensee shall be required to take all necessary steps to remedy such non-compliance within the period as specified in the notice of non-compliance ("**Remedial Period**"). During the Remedial Period, the Licensee undertakes that it will not sell such non-conforming Product(s) without the prior written consent of the Licensor.
- h. If the report of the Analysis referred to in Clause 5g shows that:
  - (i) the Product(s) comply with the Healthier Choice Symbol Nutrient Guidelines but deviate from nutritional information in the Panel, the Licensee is permitted to continue its use of Trademark on the Product(s) and in the Promotional Materials PROVIDED THAT the Licensee takes all necessary steps to amend the Panel during the period as specified in the notice of non-compliance ("**Remedial Period**") and the Licensor approves any amendments made by the Licensee to the Panel in order to accurately reflect the contents in the report of the Analysis referred to in Clause 5g above; or
  - (ii) the Product(s) do not comply with the Healthier Choice Symbol Nutrient Guidelines, the Licensor shall be entitled to terminate this Agreement in its entirety or in respect of any Product(s), by notice in writing, with immediate effect.
- i. For the avoidance of doubt, during the Remedial Period, the Licensee shall not use the Trademark on the Product(s) and in the Promotional Materials without the prior written consent of the Licensor.
- j. If the Licensee is dissatisfied with the Licensor's findings of non-compliance pursuant to Clause 5g, the Licensee may write to the Licensor to request for a review of the Licensor's findings of non-compliance. The Licensee acknowledges and agrees that the Licensor is entitled to exercise its discretion and reject such request for review.

## 6 OWNERSHIP AND ADOPTION OF TRADEMARK

- A. The Licensee recognises the Licensor's ownership and title to the Trademark and the Licensor's entitlement to authorise the use of the Trademark, and shall not claim adversely to the Licensor any right, title or interest in and to the Trademark. The Licensee further agrees not to register or use or attempt to register or to use, or to aid any third party in registering or using or attempting to register or to use, any trademark which may be confusingly similar to the Trademark.
- B. All goodwill resulting from the use by the Licensee of the Trademark during the term of this Agreement shall inure to the exclusive benefit of the Licensor. The Licensee shall execute such documents as the Licensor shall require in order to obtain the full benefit of such goodwill.
- C. The covenants contained herein shall survive termination of this Agreement.

## 7 MISUSE OF TRADEMARK

- a. The Licensee will promptly notify the Licensor of any and all applications for registration and registrations of conflicting marks, as well as any (and all) infringements, imitations, illegal use or misuse of the Trademark or use of trademark, tradenames or marks similar to the Trademark which come to the Licensee's attention. The Licensee will not, at any time, without prior written approval of the Licensor, take any action in any court, administrative agency, arbitration association, governmental association, governmental body or otherwise, either in Singapore or elsewhere, to prevent the infringement, imitation, illegal use or misuse of the Trademark which come to the Licensee's attention or oppose or cancel or attempt to cancel applications or registrations, respectively, of conflicting marks. The Licensee undertakes without any reservation whatsoever, to render to the Licensor all assistance in connection with any matter pertaining to the protection of the Trademark, whether in a court, administrative agency, arbitration association, governmental association, governmental body or otherwise, and promptly to make available to the Licensor, its representatives, agents and attorneys, all files, records and other material and information in its possession or control pertaining to the manufacture, purchase, distribution and sale of other products and the provision of services (including retail services) identified by other marks similar to the Trademark.
- b. The Licensor shall have the right, but not the obligation, to commence or to take over the conduct of all actions and proceedings (whether in its own name or that of the Licensee) relating to the Trademark. The Licensor shall bear the costs and expenses of any actions or proceedings commenced or taken over by the Licensor and any costs or damages recovered in connection with such actions or proceedings shall be for the account of the Licensor.

## 8 LIMITATION AND EXCLUSION OF LIABILITY AND INDEMNITY

- a. The Licensor makes no warranty or representation that the Trademark does not infringe marks or names of third parties and the Licensee shall be solely responsible for defending any third party claims or actions for trademark or trade name infringement which may be brought against the Licensor or the Licensee based on or resulting from the use by the Licensee of the Trademark.

- b. Save for the Licensor's certification that the Product(s) conforms to the standards of the Licensor's Healthier Choice Symbol Programme, the Licensee acknowledges that the grant of the licence herein does not constitute any warranty or representation by the Licensor that any Product(s) are of any particular quality or has any special properties making it fit for a particular purpose.
- c. The Licensor does not, by the grant of the licence herein, accept any liability to the Licensee nor to any other party for any damage, loss or injury caused, whether directly or indirectly, as a result of the use of the Product(s).
- d. The Licensee undertakes and agrees that it will indemnify and hold the Licensor, its servants, agents and employees harmless from and against all costs and/or expenses (including, without limitation, legal costs, fees and expenses), actions, proceedings, claims, demands and damages arising from:-
  - (i) a breach of this Agreement by the Licensee and made or claimed by third parties; or
  - (ii) the Licensee's use of the Trademark on Product(s) which do not comply with the Healthier Choice Nutrient Symbol Guidelines.

## 9 TERM AND TERMINATION

- a. The Licensee may terminate this Agreement in its entirety or in respect of any Product(s) at any time, by notice in writing, with immediate effect.
- b. In addition to the rights of termination provided elsewhere in this Agreement, the Licensor shall be entitled to terminate this Agreement, by notice in writing, with immediate effect upon the happening of one or more of the following events:-
  - (i) the Licensor discontinues the Healthier Choice Symbol Programme;
  - (ii) the Licensee becomes insolvent, is declared bankrupt, compulsorily or voluntarily enters into liquidation, or has a receiver appointed of all or any part of its assets;
  - (iii) the Licensee commits a material breach of the terms and conditions of this Agreement and such breach remains unrectified for a period of seven (7) days ("**Rectification Period**") after notice to rectify the same has been given. For the avoidance of doubt, any request by the Licensee to vary or extend the Rectification Period shall be made to the Licensor in writing, and the Licensor may, in its sole and unfettered discretion, decide to refuse such request for a variation or extension of the Rectification Period;
  - (iv) the Licensee ceases or threatens to cease to carry on its business or any substantial part thereof or changes or threatens to change the nature or scope of its business or to sell or dispose of all or a substantial part of its business or assets; or
  - (v) the Licensee challenging the validity of or the entitlement of the Licensor to use or license the use of the Trademark.
- c. In case of any termination under this Agreement, the Licensor shall not be liable to the Licensee for any special, consequential or incidental damages. The Licensee hereby specifically disclaims any right to compensation of any sort as a result of any termination effected in accordance with this Agreement.
- d. Termination of this Agreement for any cause shall not release a Party from any liability which at the time of termination has already accrued to another Party or which thereafter may accrue in respect of any act or omission prior to such termination. This Clause shall survive the termination of this Agreement.

## 10 CONSEQUENCES OF TERMINATION

- a. Upon termination of this Agreement in its entirety or in respect of any Product(s) for any reason, the rights and licence granted hereunder to the Licensee shall cease and determine and the Licensee shall forthwith discontinue any and all use of the Trademark save that, with the Licensor's prior written consent, the Licensee may continue to distribute/sell the Product(s) bearing the Trademark in stock at the date of termination for such period as the Licensor may permit PROVIDED THAT the Licensee shall comply with the terms and conditions hereof in respect of the sales of such Product(s) during such period.
- b. Upon termination of the Agreement in its entirety or in respect of any Product(s), the Licensor may request the Licensee to take the following steps before the expiration of such period as notified by the Licensor to the Licensee:
  - (i) delete or remove the Trademark from the Product(s) and/or Promotional Materials; or
  - (ii) where such deletion or removal is not reasonably practicable, to cease the sales of all Product(s) bearing the Trademark and cease use of all Promotional Materials and the like and all other materials or documents in the possession or under the control of the Licensee to which the Trademark is/are then affixed or approved.
- c. The Licensee acknowledges and agrees that if it fails to comply with the requirements as set out in this Clause 10, the Licensor is entitled to take steps to publish a notice of non-compliance in any manner that it deems fit.
- d. The covenants contained herein shall survive termination of this Agreement.

## 11 MISCELLANEOUS

- a. This Agreement supersedes any previous written or oral agreement between the Parties in relation to the matters dealt with in this Agreement and contains the whole agreement between the Parties relating to the subject matter of this Agreement at the date hereof to the exclusion of any terms implied by law which may be excluded by contract. Each of the Parties hereto acknowledges that it has not been induced to enter into this Agreement by any representation, warranty or undertaking not expressly incorporated into it.
- b. The Parties acknowledge and agree that the Licensor may modify, amend or vary any terms of this Agreement at any time, subject to the Licensor's provision of written notice to the Licensee.
- c. This Agreement shall be binding on the Parties hereto and their respective successors and assigns.
- d. All Parties represents and warrants to the other Party the person signing this Agreement on behalf of such Party's behalf has all the necessary power, authority, licences and consents to bind the Party on whose behalf the person is executing this Agreement, and that by signing this Agreement, such Party shall be bound by the terms contained in this Agreement.
- e. The Licensee shall not be entitled to assign this Agreement or any of its rights and obligations hereunder without the prior written consent of the Licensor.
- f. Nothing in this Agreement shall be deemed to constitute a partnership between the Parties hereto nor constitute any Party the agent of any other Party for any purpose.
- g. If any provision of this Agreement or part thereof is rendered void, illegal or unenforceable in any respect under any law, the validity, legality or enforceability of the remaining provisions shall not in any way be affected or impaired thereby.
- h. All notices to be given under this Agreement shall be hand-delivered, or made by fax or registered mail (postage prepaid) or by electronic mail, to the address or fax number or electronic mail address set out below:-

the Licensor : **HEALTH PROMOTION BOARD**  
 3 Second Hospital Avenue,  
 Singapore 168937  
 Fax: 6438 3609  
 E-mail: HPB\_HCSadmin@hpb.gov.sg

the Licensee : The contact details of the Licensee are set out in the Application Form.

- i. Notices, demands or other communications required or permitted to be given or made hereunder shall be in writing and delivered personally or sent by prepaid post with recorded delivery or legible fax or electronic mail addressed to the intended recipient at its address set out in this Agreement or to such other address or fax number or electronic mail address as any party may from time to time duly notify to the other. Any such notice, demand or communication shall, unless the contrary is proved, be deemed to have been duly served, if given or made by electronic mail, instantaneously or, if given or made by fax, on the next following business day in the place of receipt or, if given or made by letter, 48 hours after posting and in proving the same, it shall be sufficient to show, in the case of a letter, that the envelope containing the same was duly addressed, correctly stamped and posted and, in the case of a fax, that such fax was duly dispatched to a current fax number of the addressee and, in the case of an electronic mail, that it was addressed to the current electronic mail address of the recipient and a delivery receipt was received.
- j. The Licensee shall bear all costs and expenses incurred by the Parties in connection with the preparation and execution of this Agreement.

## 12 DISCLOSURE

The Licensee hereby acknowledges that the Licensor shall be entitled to disclose the particulars of the Product(s) including the trade name, product name, nutritional contents and ingredients as disclosed on the product label to any third party for the purposes of informing and/or educating the public or such other purpose as the Licensor shall reasonably deem fit.

## 13 GOVERNING LAW AND ARBITRATION

- a. This Agreement shall be governed by and construed in accordance with the laws of Singapore
- b. All disputes between the Parties as to any matter arising out of or in connection with this Agreement shall be referred to the arbitration in Singapore of a single arbitrator to be appointed by agreement between the Parties or, if such agreement is not reached within 14 days of the date on which the name of a proposed arbitrator shall have been submitted by either Party to the other, to be appointed by the Chairman of the Singapore International Arbitration Centre and provided that such arbitration shall be construed in accordance with the ICC Rules.

**IN WITNESS** whereof this Agreement has been entered into the day and year first above written.

ACCEPTED FOR AND ON BEHALF OF  
**HEALTH PROMOTION BOARD**

Name: **Ann Low**  
 Designation: **Senior Deputy Director**

ACCEPTED FOR AND ON BEHALF OF  
**F&N Foods Pte Ltd**

Name: **Norman Phua**  
 Designation: **Brand Manager**



## SCHEDULE 1

THE TRADEMARK

## SCHEDULE 2

THE PRODUCT(S)

Based on the provisions of this Schedule, the Licensee shall use the Trademark (as specified in [SCHEDULE 2](#)) together with the Approved Descriptor(s) (as specified in this Schedule) on the Product(s).

**Trademark and Approved Descriptor(s)**

The Trademark and Approved Descriptor(s) should only be used on the Product(s) if the Product(s) is to be sold in a retail setting. This includes, but is not limited to, products sold in markets, supermarkets, minimarts and convenience stores.

BRAND NAME	PRODUCT NAME	PACKAGE SIZE	PACKAGE DESCRIPTION	APPROVED DESCRIPTOR
F&N Fruit Tree Fresh	100% Apple Juice No Sugar Added	250ml		No Added Sugar
F&N Fruit Tree Fresh	100% Apple Juice No Sugar Added	1L		No Added Sugar
F&N Fruit Tree Fresh	100% Blueberry Cranberry & Mixed Fruit Juice No Sugar Added	250ml		No Added Sugar
F&N Fruit Tree Fresh	100% Blueberry Cranberry & Mixed Fruit Juice No Sugar Added	1L		No Added Sugar
F&N Fruit Tree Fresh	100% Cranberry Pomegranate & Apple Juice No Sugar Added	250ml		No Added Sugar
F&N Fruit Tree Fresh	100% Cranberry Pomegranate & Apple Juice No Sugar Added	1L		No Added Sugar
F&N Fruit Tree Fresh	100% Orange Juice Drink No Sugar Added	250ml		No Added Sugar
F&N Nutrisoy	Fresh Soya Milk with Almond High Calcium Reduced Sugar	1L	Sold in bulk (2 pcs)	Lower in Sugar Higher in Calcium



BRAND NAME	PRODUCT NAME	PACKAGE SIZE	PACKAGE DESCRIPTION	APPROVED DESCRIPTOR
F&N Nutrisoy	Fresh Soya Milk with Almond High Calcium Reduced Sugar	475ml		Lower in Sugar Higher in Calcium
F&N Magnolia	UHT Higher Calcium Low Fat Milk with Fresh Milk	250ml		Higher in Calcium Lower in Saturated Fat
F&N Magnolia	UHT Higher Calcium Low Fat Milk with Fresh Milk	1L		Higher in Calcium Lower in Saturated Fat
F&N Nutrisoy	Fresh Soya Milk High Calcium Reduced Sugar	1L	Sold in bulk (2 pcs)	Lower in Sugar Higher in Calcium
F&N Nutrisoy	Fresh Soya Milk High Calcium Reduced Sugar	475ml		Lower in Sugar Higher in Calcium
F&N Nutrisoy	Fresh Soya Milk High Calcium	475ml		Lower in Sugar Higher in Calcium
F&N Nutrisoy	Fresh Soya Milk High Calcium	1L	Sold in bulk (2 pcs)	Lower in Sugar Higher in Calcium
Sunkist	100% Freshly Squeezed Pure Premium Orange Juice Lots of Pulp	1L		No Added Sugar
Sunkist	100% Freshly Squeezed Pure Premium Orange Juice Original	1L		No Added Sugar
Sunkist	Orange Juice Drink No Sugar Added	250ml		No Added Sugar
Sunkist	Orange Juice Drink No Sugar Added	2L		No Added Sugar
Sunkist	100% Premium Orange Juice No Sugar Added	1.89L		No Added Sugar
Sunkist	100% Premium Orange Juice No Sugar Added	1L	Paper Carton	No Added Sugar
Magnolia	Super Slim Milk	1L		Higher in Calcium Lower in Saturated Fat
Milkmaid	Low Fat Sweetened Condensed Skimmed Milk	392g		Lower in Saturated Fat
Carnation	Low Fat High Calcium Evaporated Milk	405g		Lower in Saturated Fat
F&N Nutrisoy	Omega No Sugar Added Fresh Soya Milk	1L	Sold in bulk (2 pcs)	Lower in Sugar Higher in Calcium
F&N Nutrisoy	Omega Reduced Sugar Fresh Soya Milk	1L	Sold in bulk (2 pcs)	Lower in Sugar Higher in Calcium
Nutrisoy	Omega No Sugar Added High Calcium Fresh Soya Milk	475ml		Lower in Sugar Higher in Calcium
F&N Nutriwell	BARLEY	1L	Sold in bulk (2 pcs)	Lower in Sugar
F&N Nutriwell	BARLEY	475ml		Lower in Sugar
F&N Nutriwell	CHRYSANTHEMUM WITH WOLFBERRY	1L	Sold in bulk (2 pcs)	Lower in Sugar

BRAND NAME	PRODUCT NAME	PACKAGE SIZE	PACKAGE DESCRIPTION	APPROVED DESCRIPTOR
F&N Nutriwell	CHRYSANTHEMUM WITH WOLFBERRY	475ml		Lower in Sugar
F&N Nutriwell	WATER CHESTNUT & SUGAR CANE	1L	Sold in bulk (2 pcs)	Lower in Sugar
F&N Nutriwell	WATER CHESTNUT & SUGAR CANE	475ml		Lower in Sugar
F&N Nutrisoy	Soya Milk with Calcium Reduced Sugar (new)	250ml		Lower in Sugar Higher in Calcium
F&N Seasons	Nutriwell Barley Drink Reduced Sugar	250ml	Sold in bulk (6 pcs)	Lower in Sugar
F&N Seasons	Nutriwell White Chrysanthemum Tea	380ml		Lower in Sugar
F&N Seasons	Nutriwell White Chrysanthemum Tea	1L		Lower in Sugar
F&N Magnolia	Low Fat Hi-Cal Milk	1L		Higher in Calcium Lower in Saturated Fat
F&N Magnolia	Low Fat Hi-Cal Milk	500ml		Higher in Calcium Lower in Saturated Fat
F&N Magnolia	Low Fat Hi-Cal Milk	200ml		Higher in Calcium Lower in Saturated Fat
F&N Seasons	Nutriwell Barley Drink	300ml		Lower in Sugar
F&N Magnolia	Yoghurt Smoothie Strawberry with Nata De Coco	800ml	Sold in bulk (2 pcs)	Lower in Sugar Lower in Saturated Fat
F&N Magnolia	Yoghurt Smoothie Strawberry with Nata De Coco	250ml		Lower in Sugar Lower in Saturated Fat
F&N Magnolia	Yoghurt Smoothie Mixed Berries with Nata De Coco	800ml	Sold in bulk (2 pcs)	Lower in Sugar Lower in Saturated Fat
F&N Magnolia	Yoghurt Smoothie Mixed Berries with Nata De Coco	250ml		Lower in Sugar Lower in Saturated Fat
F&N Magnolia	Yoghurt Smoothie Mango with Orange Sacs	800ml	Sold in bulk (2 pcs)	Lower in Sugar Lower in Saturated Fat
F&N Magnolia	Yoghurt Smoothie Mango with Orange Sacs	250ml		Lower in Sugar Lower in Saturated Fat
F&N Seasons	Nutriwell White Chrysanthemum Tea 300ml	300ml		Lower in Sugar
F&N Seasons	Nutriwell White Chrysanthemum Tea 250ml	250ml	Sold in bulk (6 pcs)	Lower in Sugar
Pura	Pura Slim Milk Drink	1L		Higher in Calcium Lower in Saturated Fat
F&N Nutriwell	F&N NutriWell Snow Fungus with Wolfberry	1L	Sold in bulk (2 pcs)	Lower in Sugar

BRAND NAME	PRODUCT NAME	PACKAGE SIZE	PACKAGE DESCRIPTION	APPROVED DESCRIPTOR
F&N Nutriwell	F&N NutriWell Snow Fungus with Wolfberry	475ml		Lower in Sugar
F&N Nutrisoy	Soya Milk with Calcium Reduced Sugar 1L (new)	1L		Lower in Sugar Higher in Calcium
F&N Magnolia	Lo-Fat Hi-Cal with Fresh Milk & Omega 3 DHA	1L	Tetra Rex Carton	Higher in Calcium Lower in Saturated Fat
F&N Magnolia	Lo-Fat Hi-Cal with Fresh Milk & Omega 3 DHA	200ml		Higher in Calcium Lower in Saturated Fat
F&N Magnolia	Lo-Fat Hi-Cal Oat Milk with Fresh Milk	1L		Higher in Calcium Lower in Saturated Fat
F&N Magnolia	Lo-Fat Hi-Cal Oat Milk with Fresh Milk	500ml		Higher in Calcium Lower in Saturated Fat
Coco Life	Coconut Water Juice Drink	1L		Lower in Sugar
Coco Life	Coconut Water Juice Drink	330ml		Lower in Sugar
F&N ICE MOUNTAIN	SPARKLING WATER (LEMON)	375ml		Sugar Free
F&N ICE MOUNTAIN	SPARKLING WATER (LEMON)	4X375ml		Sugar Free
F&N ICE MOUNTAIN	SPARKLING WATER (LEMON)	24X375ml		Sugar Free
F&N ICE MOUNTAIN	SPARKLING WATER (LEMON)	325ml		Sugar Free
F&N ICE MOUNTAIN	SPARKLING WATER (LEMON)	6X325ml		Sugar Free
F&N ICE MOUNTAIN	SPARKLING WATER (Grapefruit)	375ml		Sugar Free
F&N ICE MOUNTAIN	SPARKLING WATER (Grapefruit)	24X375ml		Sugar Free
F&N ICE MOUNTAIN	SPARKLING WATER (Grapefruit)	325ml		Sugar Free
F&N ICE MOUNTAIN	SPARKLING WATER (Grapefruit)	6X325g		Sugar Free
F&N ICE MOUNTAIN	PURE DRINKING WATER	600ml		Sugar Free
F&N ICE MOUNTAIN	PURE DRINKING WATER	1.5L		Sugar Free
F&N ICE MOUNTAIN	PURE DRINKING WATER	500ml		Sugar Free
F&N ICE MOUNTAIN	PURE DRINKING WATER	12X1.5L		Sugar Free

BRAND NAME	PRODUCT NAME	PACKAGE SIZE	PACKAGE DESCRIPTION	APPROVED DESCRIPTOR
F&N ICE MOUNTAIN	PURE DRINKING WATER	24X600ml		Sugar Free
Fruit Tree Fresh	Wonders Luscious Berries with Chia Seeds	1L		No Added Sugar
Fruit Tree Fresh	Wonders Luscious Berries with Chia Seeds	250ml		No Added Sugar
F&N ICE MOUNTAIN	Sparkling Water (Classic)	375ml		Sugar Free
F&N ICE MOUNTAIN	Sparkling Water (Classic)	4X375ml		Sugar Free
F&N ICE MOUNTAIN	Sparkling Water (Classic)	24X375ml		Sugar Free
F&N Seasons	Ice Lemon Tea Reduced Sugar (MY)	500ml		Lower in Sugar
F&N Seasons	Ice Lemon Tea Reduced Sugar (MY)	300ml		Lower in Sugar
F&N Seasons	Ice Lemon Tea Reduced Sugar (MY)	1.5L		Lower in Sugar
F&N Seasons	Ice Lemon Tea Reduced Sugar (MY)	250ml	Sold in bulk (6 pcs)	Lower in Sugar
F&N Fruit Tree Fresh	No Sugar added Orange Juice	1L		No Added Sugar
Magnolia	Low Fat Hi Cal Chocolate Flavoured Milk with Fresh Milk	1L		Higher in Calcium Lower in Saturated Fat
Magnolia	Low Fat Hi Cal Chocolate Flavoured Milk with Fresh Milk	200ml		Higher in Calcium Lower in Saturated Fat
F&N	Orange Zero Sugar	325ml		Sugar Free
F&N	Orange Zero Sugar	6X325ml		Sugar Free
F&N	Orange Zero Sugar	24X325ml		Sugar Free
F&N	Orange Zero Sugar	24X325ml		Sugar Free
F&N	Sarsi Zero Sugar	6X325ml		Sugar Free
F&N	Sarsi Zero Sugar	325ml		Sugar Free
F&N	Sarsi Zero Sugar	24X325ml		Sugar Free
F&N	Sarsi Zero Sugar	24X325ml		Sugar Free
F&N	Sarsi Zero Sugar	1.5L		Sugar Free
F&N Seasons	White Chrysanthemum No Sugar Unsweetened	250ml	Sold in bulk (6 pcs)	Sugar Free
100PLUS	ACTIVE Non-Carbonated Drink	500ml		Lower in Sugar
100PLUS	ACTIVE Non-Carbonated Drink	1.5L		Lower in Sugar

BRAND NAME	PRODUCT NAME	PACKAGE SIZE	PACKAGE DESCRIPTION	APPROVED DESCRIPTOR
100PLUS	ACTIVE Non-Carbonated Drink	300ml		Lower in Sugar
100PLUS	ACTIVE Non-Carbonated Drink	6X300ml		Lower in Sugar
100PLUS	ACTIVE Non-Carbonated Drink	12X300ml		Lower in Sugar
100PLUS	Orange	1.5L		Lower in Sugar
100PLUS	Orange	500ml		Lower in Sugar
100PLUS	Original	325ml		Lower in Sugar
100PLUS	Original	1.5L		Lower in Sugar
100PLUS	Original	500ml		Lower in Sugar
100PLUS	Original	12X325ml		Lower in Sugar
100PLUS	Original	6X325ml		Lower in Sugar
100PLUS	Original	12X1.5L		Lower in Sugar
100PLUS	Original	24X325ml		Lower in Sugar
100PLUS	Original	24X500ml		Lower in Sugar
100PLUS	Lemon Lime	1.5L		Lower in Sugar
100PLUS	Lemon Lime	500ml		Lower in Sugar
100PLUS	Lemon Lime	325ml		Lower in Sugar
F&N	Club Soda Water	1.5L		Sugar Free
100PLUS	Zero Sugar	1.5L		Sugar Free
100PLUS	Zero Sugar	325ml		Sugar Free
100PLUS	Zero Sugar	6X325ml		Sugar Free
100PLUS	Zero Sugar	500ml		Sugar Free
100PLUS	Zero Sugar	24X325ml		Sugar Free
100PLUS	Zero Sugar	12X1.5L		Sugar Free
100PLUS	Zero Sugar	24X325ml		Sugar Free
100PLUS	Zero Sugar	24X500ml		Sugar Free
F&N	F&N Lychee Pear	1.5L		Lower in Sugar
F&N	F&N Lychee Pear	500ml		Lower in Sugar
Magnolia	SMOO UHT CHOCOLATE FLAVOURED MILK	230ml		Higher in Calcium Lower in Saturated Fat
Magnolia	SMOO UHT STRAWBERRY FLAVOURED MILK	230ml		Higher in Calcium Lower in Saturated Fat
Magnolia-aLIVE	Low Fat Yoghurt with Apple & Pomelo	1kg		Lower in Saturated Fat

BRAND NAME	PRODUCT NAME	PACKAGE SIZE	PACKAGE DESCRIPTION	APPROVED DESCRIPTOR
Magnolia-aLIVE	Low Fat Yoghurt with Apple & Pomelo	135g	Sold in bulk (4 pcs)	Lower in Saturated Fat
Magnolia-aLIVE	Low Fat Yoghurt with Aloe Vera & Nata De Coco	135g	Sold in bulk (4 pcs)	Lower in Saturated Fat
Magnolia-aLIVE	Low Fat Yoghurt with Aloe Vera & Nata De Coco	1kg		Lower in Saturated Fat
Magnolia-aLIVE	Low Fat Yoghurt with Mango & Nata De Coco	135g	Sold in bulk (4 pcs)	Lower in Saturated Fat
Magnolia-aLIVE	Low Fat Yoghurt with Mango & Nata De Coco	1kg		Lower in Saturated Fat
Magnolia-aLIVE	Low Fat Yoghurt with Mango & Nata De Coco	90g	90 (g)	Lower in Saturated Fat
Magnolia-aLIVE	Low Fat Yoghurt with Strawberry	135g	Sold in bulk (4 pcs)	Lower in Saturated Fat
Magnolia-aLIVE	Low Fat Yoghurt with Strawberry	1kg		Lower in Saturated Fat
Magnolia-aLIVE	Low Fat Yoghurt Natural Plus	135g	Sold in bulk (4 pcs)	Lower in Saturated Fat
Magnolia-aLIVE	Low Fat Yoghurt Natural Plus	1kg		Lower in Saturated Fat
Magnolia-aLIVE	Low Fat Yoghurt Natural Plus	90g	90 (g)	Lower in Saturated Fat
Magnolia-aLIVE	Low Fat Yoghurt with Mixed Berry and Aloe Vera	135g	Sold in bulk (4 pcs)	Lower in Saturated Fat
Magnolia-aLIVE	Low Fat Yoghurt with Mixed Berry and Aloe Vera	90g	90 (g)	Lower in Saturated Fat
Magnolia	Oats Lo-Fat Hi-Cal Milk	230ml		Higher in Calcium Lower in Saturated Fat
100PLUS	Blackcurrant	1.5L		Lower in Sugar
100PLUS	Blackcurrant	500ml		Lower in Sugar
100PLUS	Blackcurrant	12X1.5L		Lower in Sugar
100PLUS	Blackcurrant	24X500ml		Lower in Sugar
F&N Fruit Tree Fresh	Daily Greens Mixed Fruit Juice Drink No Sugar Added	1L		No Added Sugar
NutriWell	Snow Pear With Red Dates	475ml		Lower in Sugar
NutriWell	Snow Pear With Red Dates	1L		Lower in Sugar
Nutrisoy	High Calcium Fresh Soya Milk with Walnuts Reduced Sugar	1L	Sold in bulk (2 pcs)	Lower in Sugar Higher in Calcium
Nutrisoy	High Calcium Fresh Soya Milk with Walnuts Reduced Sugar	475ml		Lower in Sugar Higher in Calcium

BRAND NAME	PRODUCT NAME	PACKAGE SIZE	PACKAGE DESCRIPTION	APPROVED DESCRIPTOR
F&N Fruit Tree Fresh	Apple & Aloe Vera Juice Drink Less Sugar & Calories	250ml		Lower in Sugar
F&N Fruit Tree Fresh	Apple & Aloe Vera Juice Drink Less Sugar & Calories	1L		Lower in Sugar
F&N Fruit Tree Fresh	Orange with Orange Sacs and Pulps Juice Drink Less Sugar & Calories	1L		Lower in Sugar
Nutrisoy	Soya Milk Reduced Sugar with Calcium	300ml		Lower in Sugar Higher in Calcium
Magnolia	SMOO UHT VANILLA FLAVOURED MILK	230ml		Higher in Calcium Lower in Saturated Fat
Magnolia	Super Slim Skim Milk	1L	UHT milk carton	Higher in Calcium Lower in Saturated Fat
F&N Fruit Tree	Mango Juice Drink Reduced Sugar	300ml		Lower in Sugar
F&N Fruit Tree	Mango Juice Drink Reduced Sugar	24X300ml		Lower in Sugar
F&N Fruit Tree	Orange Juice Drink Reduced Sugar	300ml		Lower in Sugar
F&N Fruit Tree	Orange Juice Drink Reduced Sugar	24X300ml		Lower in Sugar
Seasons	Pu Erh Chrysanthemum Tea	300ml		No Added Sugar
Seasons	Pu Erh Chrysanthemum Tea	12X300ml		No Added Sugar
Seasons	Pu Erh Chrysanthemum Tea	380ml		No Added Sugar
Seasons	Pu Erh Chrysanthemum Tea	1L		No Added Sugar
Seasons	Pu Erh Chrysanthemum Tea	6X300ml		No Added Sugar
F&N Fruit Tree Fresh	Pink Guava Juice Drink Less Sugar & Calories	1L		Lower in Sugar
F&N Fruit Tree Fresh	Pink Guava Juice Drink Less Sugar & Calories	250ml		Lower in Sugar
F&N Fruit Tree Fresh	Mango Juice Drink Less Sugar & Calories	1L		Lower in Sugar
F&N Fruit Tree Fresh	Mango Juice Drink Less Sugar & Calories	250ml		Lower in Sugar
F&N Fruit Tree Fresh	Wonders Kale, Spinach & Broccoli Mixed Fruit Juice Drink with Chia Seeds No Sugar Added	250ml		No Added Sugar
F&N Fruit Tree Fresh	Wonders Kale, Spinach & Broccoli Mixed Fruit Juice Drink with Chia Seeds No Sugar Added	1L		No Added Sugar
Nutrisoy	High Calcium Fresh Soya Milk with Purple Sweet Potato Reduced Sugar	475ml		Lower in Sugar Higher in Calcium
Nutrisoy	High Calcium Fresh Soya Milk with Purple Sweet Potato Reduced Sugar	1L	Sold in bulk (2 pcs)	Lower in Sugar Higher in Calcium



BRAND NAME	PRODUCT NAME	PACKAGE SIZE	PACKAGE DESCRIPTION	APPROVED DESCRIPTOR
F&N	ZAPPEL	1.5L		Lower in Sugar
F&N	ZAPPEL	500ml		Lower in Sugar
F&N	ZAPPEL	325ml		Lower in Sugar
F&N	ICE CREAM SODA ZERO SUGAR	1.5L		Sugar Free
Magnolia	Purple Taro Flavoured Milk with Fresh Milk and Real Taro	1L		Lower in Sugar Lower in Saturated Fat
Magnolia	Purple Taro Flavoured Milk with Fresh Milk and Real Taro	500ml		Lower in Sugar Lower in Saturated Fat
Nutrisoy	High Calcium Fresh Soya Milk Unsweetened	1L	Sold in bulk (2 pcs)	Lower in Sugar Higher in Calcium
F&N Seasons	BLACK AND WHITE SOYA DRINK WITH GRASS JELLY	300ml	300 (ml)	Lower in Sugar
F&N Seasons	BLACK AND WHITE SOYA DRINK WITH GRASS JELLY	6X300ml	6 x 300 (ml)	Lower in Sugar
Nutrisoy	High Calcium Fresh Soya Milk with Real Oats & Quinoa (Reduced Sugar)	1L	Sold in bulk (2 pcs)	Lower in Sugar Higher in Calcium
Nutrisoy	High Calcium Fresh Soya Milk with Real Oats & Quinoa (Reduced Sugar)	475ml		Lower in Sugar Higher in Calcium
Magnolia	UHT Low Fat Higher Calcium Milk (SG formulation)	250ml		Higher in Calcium Lower in Saturated Fat
Magnolia	Low Fat Hi-Cal Milk with Omega & Beta Glucan	1L		Higher in Calcium Lower in Saturated Fat
Magnolia	Low Fat Hi-Cal Milk with Omega & Beta Glucan	500ml		Higher in Calcium Lower in Saturated Fat
F&N	Salty Lime Soda	325ml	325 (ml)	Lower in Sugar
Ice Mountain	Sparkling Water Peach	325ml	CAN	Sugar Free
F&N	Bandung	1.5L	1.5 (L)	Lower in Sugar
F&N	Bandung	500ml	PET bottle	Lower in Sugar
Magnolia-aLIVE	Low Fat Yoghurt with Strawberry	90g	90G yoghurt cup	Lower in Saturated Fat
Magnolia-aLIVE	Low Fat Yoghurt with Strawberry	135g	135G yoghurt cup	Lower in Saturated Fat
F&N Nutrisoy	Nutrisoy Fresh Soya Milk with Pandan	1L	Tetra Rex Carton	Lower in Sugar Higher in Calcium
F&N Nutrisoy	Nutrisoy Fresh Soya Milk with Pandan	475ml	Tetra Rec Carton	Lower in Sugar Higher in Calcium
F&N Magnolia	Brown Sugar & Sea Salt Low Fat Lower Sugar Flavoured Milk	1L	tetra brik	Lower in Sugar Lower in Saturated Fat

BRAND NAME	PRODUCT NAME	PACKAGE SIZE	PACKAGE DESCRIPTION	APPROVED DESCRIPTOR
F&N Magnolia	Brown Sugar & Sea Salt Low Fat Lower Sugar Flavoured Milk	500ml	tetra brik	Lower in Sugar Lower in Saturated Fat
F&N Seasons	Chrysanthemum Tea (Reduced Sugar)	250ml	Tetra	Lower in Sugar
F&N Seasons	Chrysanthemum Tea (Reduced Sugar)	300ml	Fat CAN	Lower in Sugar
F&N Seasons	Chrysanthemum Tea (Reduced Sugar)	300ml	Sleek CAN	Lower in Sugar
F&N Seasons	Chrysanthemum Tea (Reduced Sugar)	380ml	PET bottle	Lower in Sugar
F&N Seasons	Chrysanthemum Tea (Reduced Sugar)	1L	PET bottle	Lower in Sugar
F&N Seasons	Barley Drink Reduced Sugar	300ml	FAT CAN	Lower in Sugar
F&N Seasons	Barley Drink Reduced Sugar	24X300ml	Cans Carton	Lower in Sugar
F&N	Sarsi	1.5L	PET Bottle	Lower in Sugar
F&N	Orange	1.5L	PET Bottle	Lower in Sugar
F&N	Ice Cream Soda	1.5L	PET Bottle	Lower in Sugar
F&N	Grape	1.5L	PET	Lower in Sugar
F&N	Cherryade	1.5L	PET Bottle	Lower in Sugar
F&N	Fruitade	1.5L	PET Bottle	Lower in Sugar
F&N	Lychee Pear	1.5L	PET Bottle	Lower in Sugar
F&N	ZAPPEL	1.5L	PET Bottle	Lower in Sugar
F&N ICE MOUNTAIN	Pure Drinking Water (Tetra Prisma)	500ml	Tetra Prisma	Sugar Free
F&N ICE MOUNTAIN	Pure Drinking Water (Can)	300ml	SLEEK Can	Sugar Free
Fruit Tree Fresh	Reduced Sugar Apple Juice Drink	250ml	PET Bottle	Lower in Sugar
Fruit Tree Fresh	Reduced Sugar Apple Juice Drink	1L	Paper Carton	Lower in Sugar
Fruit Tree Fresh	Reduced Sugar Orange Juice Drink	1L	Paper Carton	Lower in Sugar
Fruit Tree Fresh	Reduced Sugar Mango Juice Drink	1L	Paper Carton	Lower in Sugar
Fruit Tree Fresh	Reduced Sugar Mango Juice Drink	250ml	PET Bottle	Lower in Sugar
Fruit Tree Fresh	Reduced Sugar Soursop Juice Drink	1L	Paper Carton	Lower in Sugar

BRAND NAME	PRODUCT NAME	PACKAGE SIZE	PACKAGE DESCRIPTION	APPROVED DESCRIPTOR
Fruit Tree Fresh	Reduced Sugar Soursop Juice Drink	250ml	PET Bottle	Lower in Sugar
Fruit Tree Fresh	Reduced Sugar Pink Guava Juice Drink	1L	Paper Carton	Lower in Sugar
Fruit Tree Fresh	Reduced Sugar Pink Guava Juice Drink	250ml	PET Bottle	Lower in Sugar
Carnation	Low Fat High Calcium Evaporated Milk	405g	Can	Lower in Saturated Fat
F&N ICE MOUNTAIN	Sparkling Water (Yuzu Osmanthus)	350ml	PET	Sugar Free
F&N ICE MOUNTAIN	Sparkling Water (Lychee Lavender)	350ml	PET	Sugar Free

### SCHEDULE 3

#### LICENSOR'S USAGE SPECIFICATIONS

The Trademark must always appear in the manner depicted in **SCHEDULE 1**. The Trademark must never be distorted, photographically or otherwise.

The size of the Trademark may vary, but should neither encroach on the brand name dominance of the Product(s) to infer the Product(s) is generic to the Licensor, nor be too small to be legible provided always that the size of the Trademark should not be smaller than 15mm x 15mm.

All reproductions of the Trademark must be approved by the Licensor at artwork stage.

#### Trademark for use on Product Packaging

The size, proportion and placement relationships of the elements are shown in this guide. In all situations, the digital artwork should be used and the HCS should never be modified in any way.

#### Grid

The grid is determined by one cap height of 'H' in the Trademark. During reproduction, please check the construction grid to ensure each section of the Trademark is within grid specifications.





#### Font type

Helvetica Neue Bold

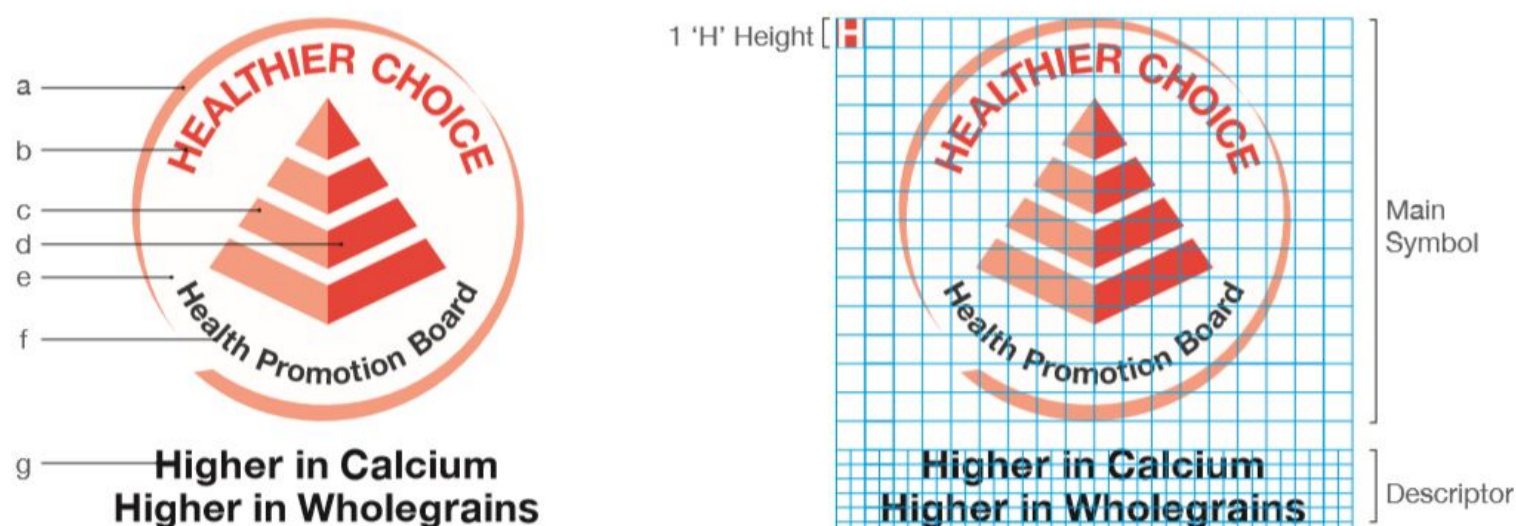
#### Colour palette

The Trademark may appear in full colour CMYK or Pantone. All colour specifications listed are to be treated as guidelines. Please refer to the Pantone codes for precise colour accuracy.



	b, d	a, c	g	f	e
					
<b>Pantone®</b>	PMS 032 C	50% PMS 032 C	PMS Black C	90% PMS Black C	White Base
<b>CMYK</b>	100M 100Y	50M 50Y	100K	90K	
<b>RGB</b>	R237 G28 B36	R245 G149 B121	R0 G0 B0	R64 G64 B65	

**Clear Space**

To ensure maximum legibility and visibility, always use the appropriate amount of clear space around the Trademark. The clear space is determined by the height of the first 2 steps from the tip of the pyramid in the HCS. This also applies to the Descriptor.

**Minimum size**

To maintain legibility, the Trademark should never be smaller than 15mm wide, unless otherwise approved by the Licensor in writing. The minimum size should only be used when layout space is extremely limited. Note: Refer to last Section for the minimum size of the Trademark for application in Corporate Collaterals.



**Full Colour**

While a full colour Trademark on a clear or white background is preferred, all backgrounds to be applied to the discretion of the Licensor as long as the Trademark is shown with complete clarity with no visual distortion. The Trademark may appear on a photographic background but the photograph should not detract from the strength of the Trademark. The Trademark should not be placed on a busy pattern or distracting background that will affect the quality of the Trademark.



**Full Colour with Reverse White Descriptor**

This application can be used when logo is placed on a dark background. Guidelines for Full Colour Application apply.

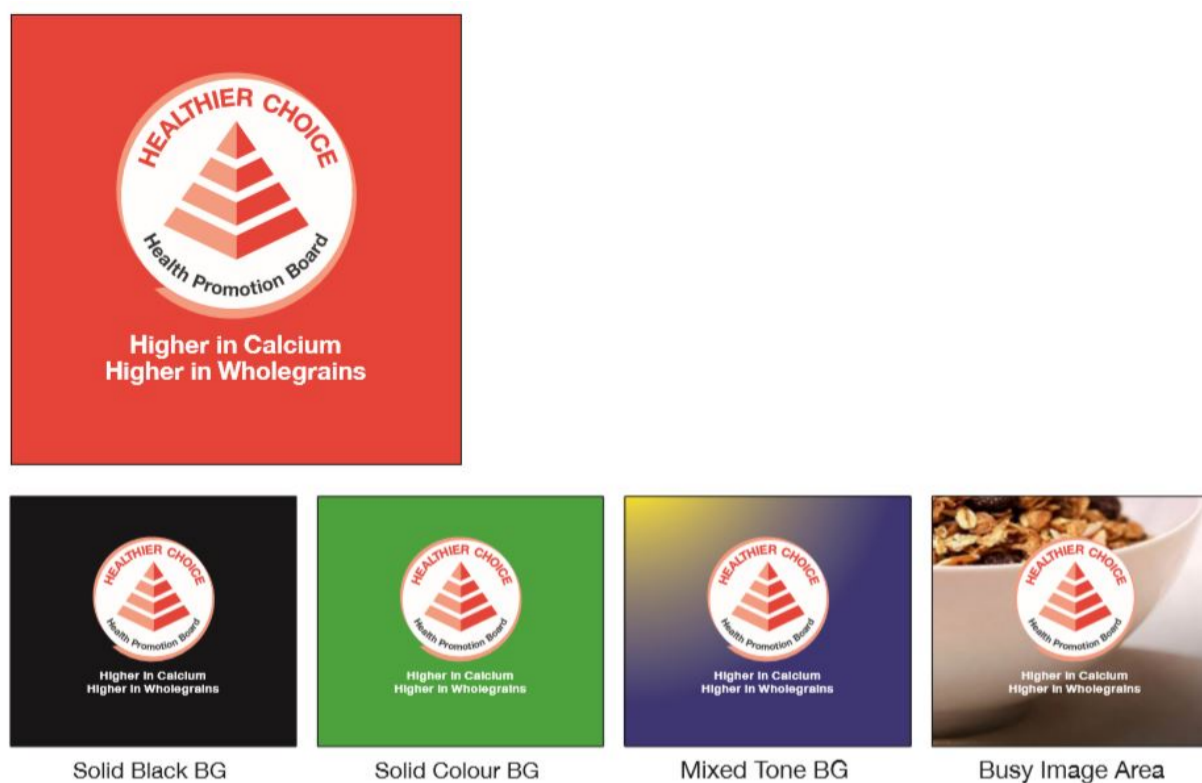

### Reverse White

Only in cases of budget constraints, some products may use a one-colour or two colour Trademark. In such cases, the Trademark have to fulfil the guidelines stated below. All monotone artworks will be assessed on a case-by-case basis in addition to the guidelines below.

The Trademark may be printed in black with the inside of the Trademark in reversed white only when:

- The product packaging is printed in two colours or less (excluding white) of which one of the colours is black (100% K)
- The Pantone Red 032 and any of the approved variations is not one of the colours printed on the packaging
- The approved variations of the Pantone Red include Pantone colours 186, 192, 199, 206, 485 and 1788. Custom colours must be submitted for approval.

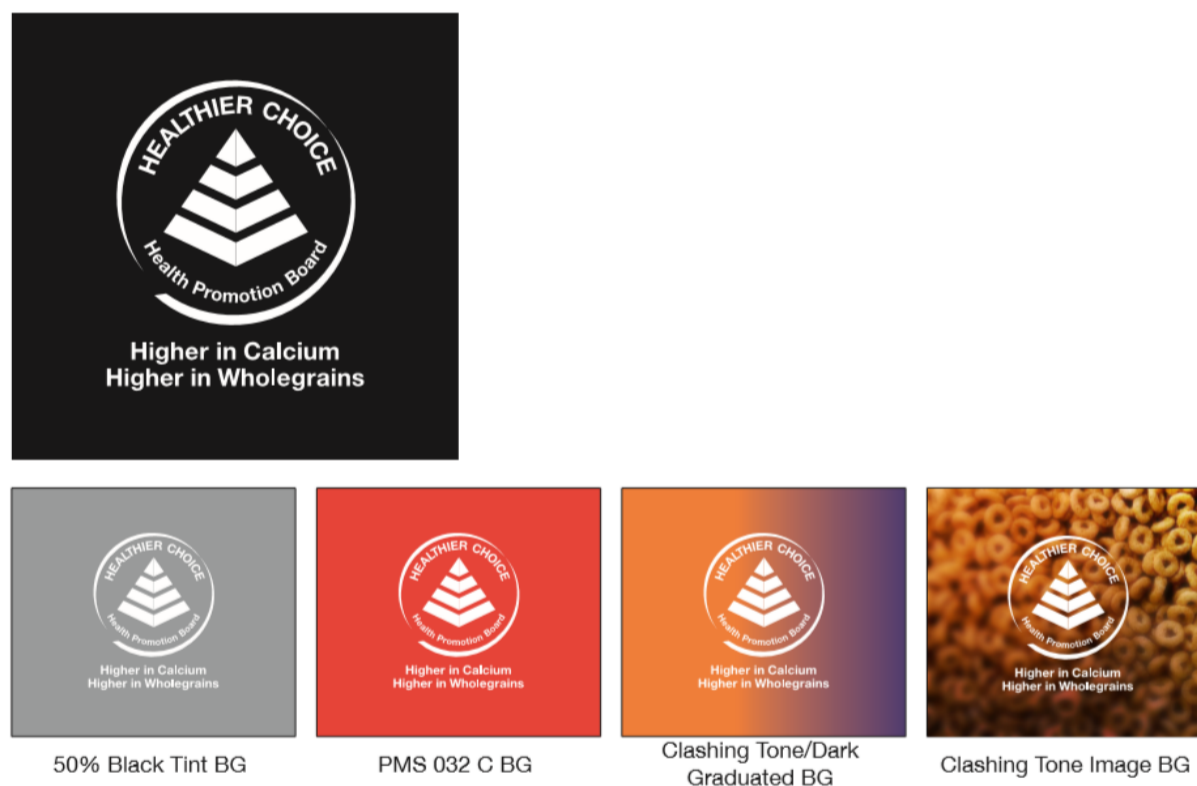

### Monotone

Only in cases of budget constraints, some products may use a one-colour or two colour Trademark. In such cases, the Trademark have to fulfil the guidelines stated below. All monotone artworks will be assessed on a case-by-case basis in addition to the guidelines below.

The Trademark may be printed in black with the inside of the Symbol in reversed white only when:

- The product packaging is printed in two colours or less (excluding white) of which one of the colours is black (100% K)
- The Pantone Red 032 and any of the approved variations is not one of the colours printed on the packaging.
- The approved variations of the Pantone Red include Pantone colours 186, 192, 199, 206, 485 and 1788. Custom colours must be submitted for approval.



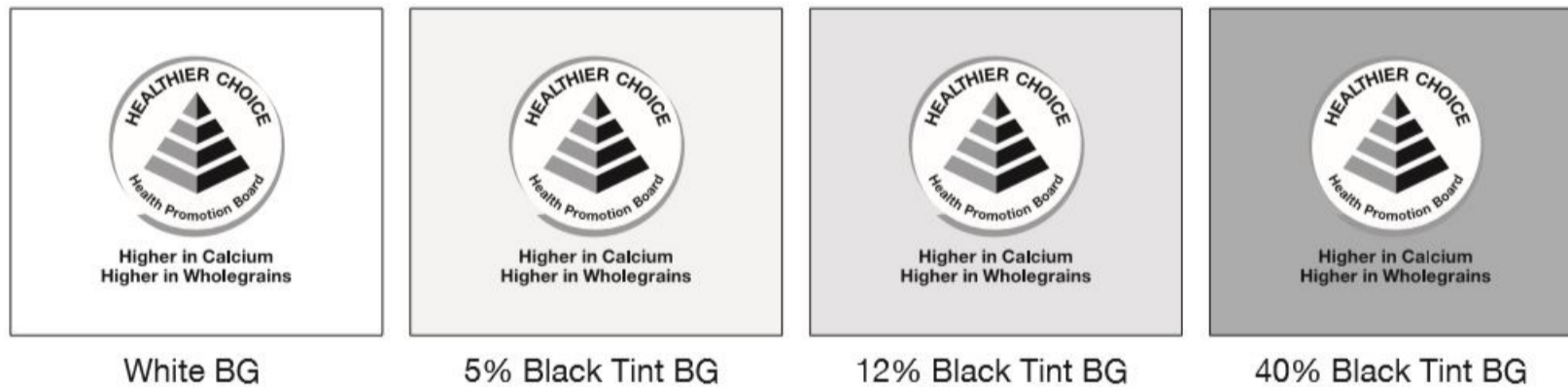
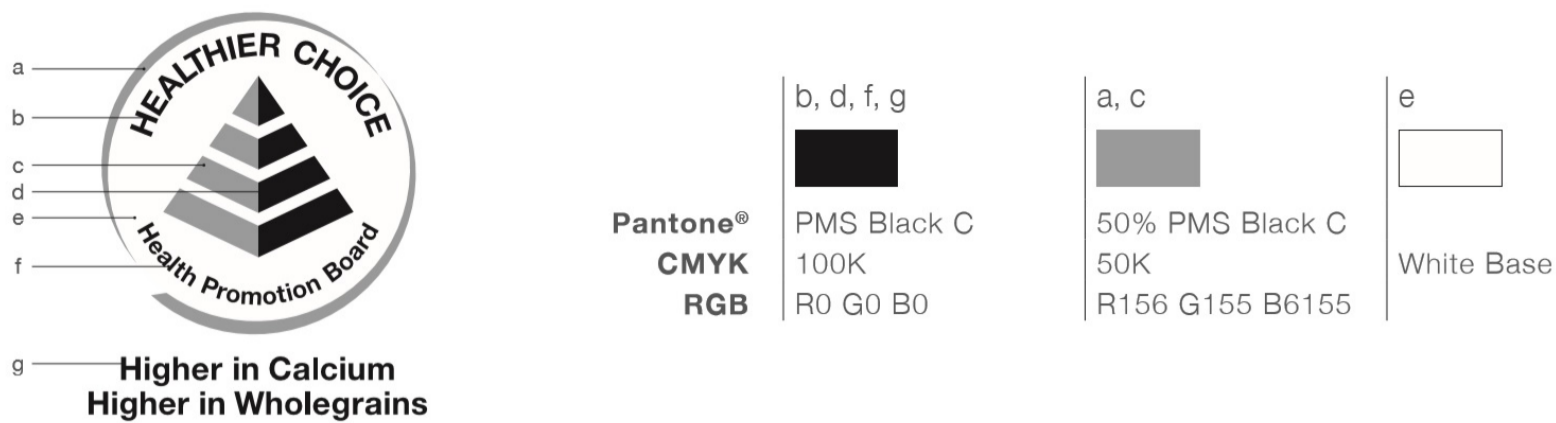

Use of the Trademark should be consistent, following the guidelines in this document. Use of an incorrect Symbol is not permitted.

Please do not:

1. Change or alter the HCS in any way such as skewing or rotating the Trademark
2. Combine with any other graphic element or use as a watermark
3. Disproportionately scaling the Trademark
4. Crop or use any part of the HCS
5. Invert the Trademark
6. Modify or substitute the fonts, add a drop shadow, glow, outline or change the colours of the HCS. Create a pattern, design element such as bullet point.
7. Place on any background that will visually distort the HCS
8. Use the Trademark main symbol without the Approved Descriptor(s) (as stated in [SCHEDULE 2](#))



**General Packaging Guidelines**

- Preferred location of the Trademark is on the front panel of the product packaging
- There should not be more than 2 reproductions of the Trademark used on each product
- Text on the Approved Descriptor(s) should be legible on the packaging
- The display surface area of the packaging is defined as the area of the face of the product where the symbol is placed (please refer to Fig. 1)
- Size of the Trademark should preferably no smaller than 15mm width when applied on the packaging (please refer to Fig.2 for calculation)
- The minimum size of 15mm width of the Trademark should be maintained if the calculations yield smaller than the recommended value.

Fig. 1

Display Surface Area =  $h \times w$

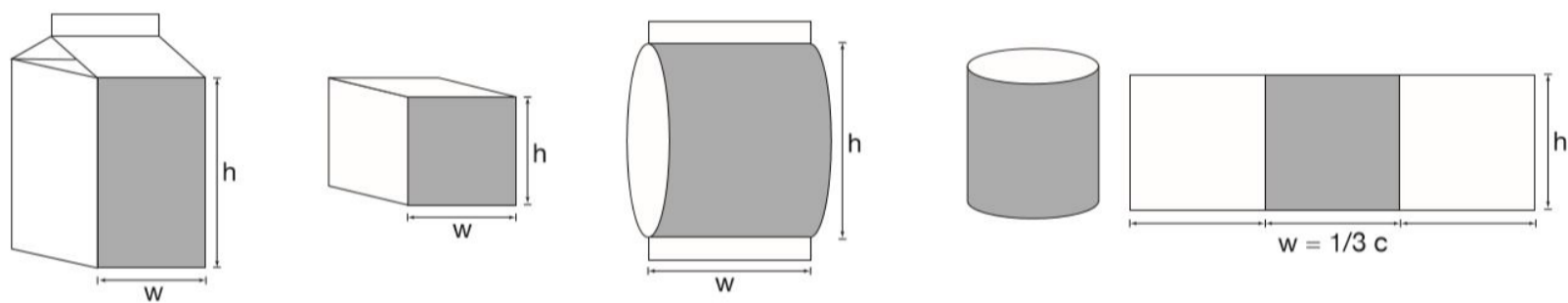
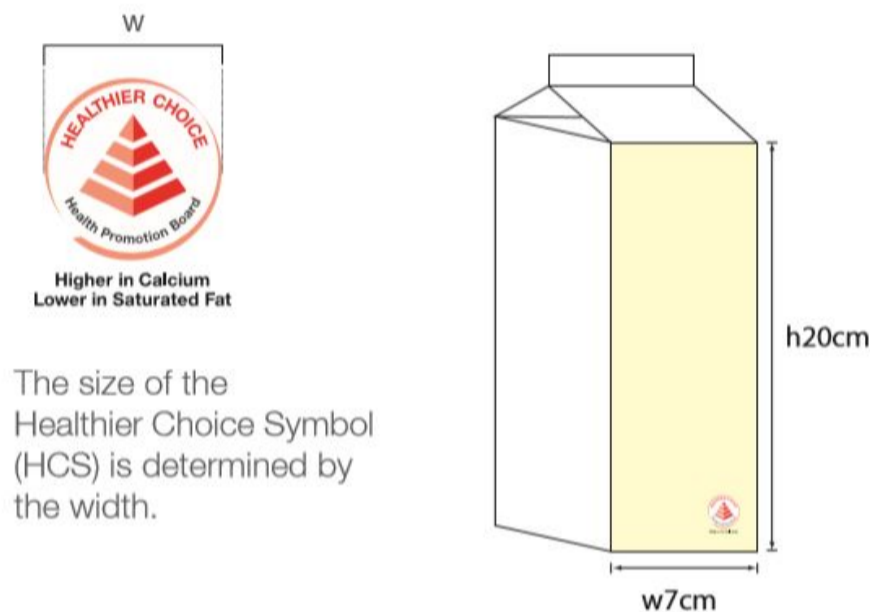

Fig. 2



To determine the **minimum size** of HCS logo width on a packaging:  
 $= h + w / 17$   
 $= w \times cm$

Example:  
 Packaging dimensions  
 $= h20cm + w7cm / 17$   
 $= w1.58cm$

The size of the Healthier Choice Symbol (HCS) is determined by the width.

Use of Trademark for Corporate Collaterals

The size, proportion and placement relationships of the elements are shown in this guide. In all situations, the digital artwork should be used and the Trademark should never be modified in any way.

**Grid**

The grid is determined by one cap height of 'H' in the Trademark. During reproduction, please check the construction grid to ensure each section of the Trademark is within grid specifications.

**Font type**

Helvetica Neue Bold

**Colour palette**

The HCS may appear in full colour CMYK or Pantone. All colour specifications listed are to be treated as guidelines. Please refer to the Pantone codes for precise colour accuracy.



	b, d	a, c	g	f	e
<b>Pantone®</b>	PMS 032 C	50% PMS 032 C	PMS Black C	90% PMS Black C	White Base
<b>CMYK</b>	100M 100Y	50M 50Y	100K	90K	
<b>RGB</b>	R237 G28 B36	R245 G149 B121	R0 G0 B0	R64 G64 B65	

**Clear Space**

To ensure maximum legibility and visibility, always use the appropriate amount of clear space around the Trademark. The clear space is determined by the height of the first 2 steps from the tip of the pyramid in the HCS. This also applies to the Approved Descriptor(s).

**Minimum size for Corporate Collaterals application**



To maintain legibility, the Trademark should never be smaller than 8mm wide, unless otherwise approved by the Licensor in writing. The minimum size should only be used when layout space is extremely limited.

